

DIRETORIA-GERAL DE DESENVOLVIMENTO NUCLEAR E TECNOLÓGICO DA MARINHA

Centro Tecnológico da Marinha no Rio de Janeiro

## Instituto de Pesquisas da Marinha (IPqM)

*Uma história de conquistas e  
exemplos de projetos executados  
pelo IPqM, com foco em Teorias e  
Técnicas de Eletrônica aplicadas.*

Apresentação Institucional

**I Simpósio em Teoria e Técnicas de Eletrônica**

**CEFET-RJ**

**01 DEZ 2022**

**CF(EN) ALI KAMEL Issmael Junior**  
**Chefe da Célula de Controle de Projetos, Engenharia**  
**e Atividades Militares (IPqM-02)**





- **Introdução (Bem Comum, Poder Nacional e Expressões de Poder);**
- **Importância da Ciência, Tecnologia & Inovação (CT&I);**
- **Sistema Nacional de Ciência, Tecnologia & Inovação (SNCTI);**
- **Estratégia Nacional em Defesa;**
- **Sistema de Ciência, Tecnologia & Inovação da Marinha do Brasil (SCTIMB);**
- **O IPqM – Uma História de Conquistas, Laboratórios e Projetos;**
- **Oportunidades para a Tríplice Hélice; e**
- **Considerações Finais.**





- **Introdução (Bem Comum, Poder Nacional e Expressões de Poder);**
- **Importância da Ciência, Tecnologia & Inovação (CT&I);**
- **Sistema Nacional de Ciência, Tecnologia & Inovação (SNCTI);**
- **Estratégia Nacional em Defesa;**
- **Sistema de Ciência, Tecnologia & Inovação da Marinha do Brasil (SCTIMB);**
- **O IPqM – Uma História de Conquistas, Laboratórios e Projetos;**
- **Oportunidades para a Tríplice Hélice; e**
- **Considerações Finais.**



# Introdução



**Formação do Estado  
Moderno - 1453/1789**



**BEM COMUM**

**Liberdade Individual  
Igualdade Fundamental  
Fraternidade entre os Povos**



# Introdução



## *Estado de Direito*

A concepção do **BEM COMUM**, circunscrita a uma sociedade nacional, dá origem a determinadas obrigações de seus membros em relação ao corpo social, consubstanciadas não apenas no plano ético e moral, mas, também, no **ordenamento jurídico**.



# Introdução



SENADO FEDERAL

Texto constitucional promulgado em 5 de outubro de 1988, com as alterações determinadas pelas Emendas Constitucionais de Revisão nº 1 a 6/94, pelas Emendas Constitucionais nº 1/92 a 91/2016 e pelo Decreto Legislativo nº 186/2008.

## CONSTITUIÇÃO

da República Federativa do Brasil

A concepção de uma sociedade nacional, com obrigações de ordem social, consubstanciada em valores morais, mas, t

ita a uma sociedade organizada em torno de valores éticos e jurídicos.



BRASIL. Ministério da Defesa. [Escola Superior de Guerra]. – Rio de Janeiro: ESG, 2019. 164 p.: il.

do Poder Nacional /



# Introdução

## NAÇÃO



**Grupo complexo, constituído por grupos sociais distintos que, em princípio, mas não necessariamente, ocupam um mesmo espaço territorial, compartilham da mesma evolução histórico-cultural e dos mesmos valores, movidos pela vontade de comungar um mesmo destino.**



# Introdução

## ESTADO



**NAÇÃO POLITICAMENTE  
ORGANIZADA**







## *Vontade Nacional*

Surge na busca e na  
promoção do BEM COMUM.





## *Vontade Nacional*

Art. 3º da CF1988: Constituem objetivos fundamentais da República Federativa do Brasil:

- I - construir uma sociedade livre, justa e solidária;
- II - garantir o desenvolvimento nacional;
- III - erradicar a pobreza e a marginalização e reduzir as desigualdades sociais e regionais;
- IV - promover o bem de todos, sem preconceitos de origem, raça, sexo, cor, idade e quaisquer outras formas de discriminação.

**Surge na busca e na  
promoção do BEM COMUM.**



# Introdução



*No caso das decisões de Estado, os fins são os objetivos próprios da cultura nacional.*

**FINS**

***Objetivos Nacionais***



# Introdução



***Poder Nacional***

**MEIOS**

E os meios são os recursos que a Nação aciona, principalmente por intermédio do Estado, para alcançar e manter aqueles fins



# Introdução



## Dimensão Internacional



# Introdução



## Conjuntura Atual (foco Defesa)



Foz do Rio Doce – Efeito do Rompimento da Barragem Samarco - 5/11/2015



Manchas de óleo no NE - 2019



Combate ao Narcotráfico



Pesca ilegal



Polarização Política



Mudanças Climáticas

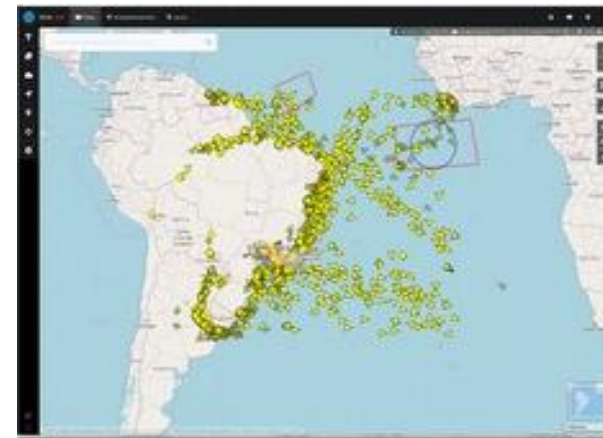

Controle do tráfego Marítimo





# Introdução

## Conjuntura Atual (foco Defesa): 3º offset tecnológico



### First Offset

#### Nuclear Weapons

With the purpose of deterring the Soviet Union and enabling a reduction in overall defense spending, nuclear weapons comprised the first offset strategy

### Second Offset

#### Precision Guided Weapons

Developed during the Vietnam War, these new weapons provided an enduring U.S. advantage for decades

### Third Offset

#### Including Robotics, 3D Printing, Big Data, Miniaturization

Announced in response to an erosion in U.S. asymmetric advantages and new multi-faceted threats, although details continue to be a work in progress



### THE CYBER THREAT IS REAL

- LEAD**  
 The Navy Cybersecurity Division leads by ensuring a comprehensive approach to cybersecurity is taken across all Navy missions.
- ACQUIRE**  
 Focus is on strengthening cybersecurity throughout the product lifecycle. SPAWAR is the Navy's Technical Authority for Cyber and provides the architecture and technical standards required to harden the Navy's networks and equipment.
- EQUIP**  
 Information Dominance Forces Command (NAVIDFOR) organizes, mans, trains, and equips the cybersecurity workforce.
- FIGHT**  
 U.S. Fleet Cyber Command (with Fleet commands) a full spectrum of cyber warfare capabilities across all warfighting domains.

NAVY CYBERSECURITY TEAM



O PODER permite uma Nação

EXERCER A SUA VONTADE!

- PERSUASÃO,
- COAÇÃO, ou
- FORÇA MILITAR

Mas como se  
expressa esse  
Poder?





# Introdução



## Expressões do Poder Nacional

Político  
Econômico  
Psicossocial  
Militar  
C&T



# Introdução



## Expressões do Poder Nacional

Político  
Econômico  
Psicossocial  
Militar  
C&T





- **Introdução (Bem Comum, Poder Nacional e Expressões de Poder);**
- **Importância da Ciência, Tecnologia & Inovação (CT&I);**
- **Sistema Nacional de Ciência, Tecnologia & Inovação (SNCTI);**
- **Estratégia Nacional em Defesa;**
- **Sistema de Ciência, Tecnologia & Inovação da Marinha do Brasil (SCTIMB);**
- **IPqM – Uma História de Conquistas, Laboratórios e Projetos;**
- **Oportunidades para a Tríplice Hélice; e**
- **Considerações Finais.**



# Importância da CT&I



Figura 1.2: Investimento em pesquisa e desenvolvimento como proporção do PIB, por região e países selecionados, 2014 e 2018 (%)

Os dados de 2014 são mostrados entre parênteses

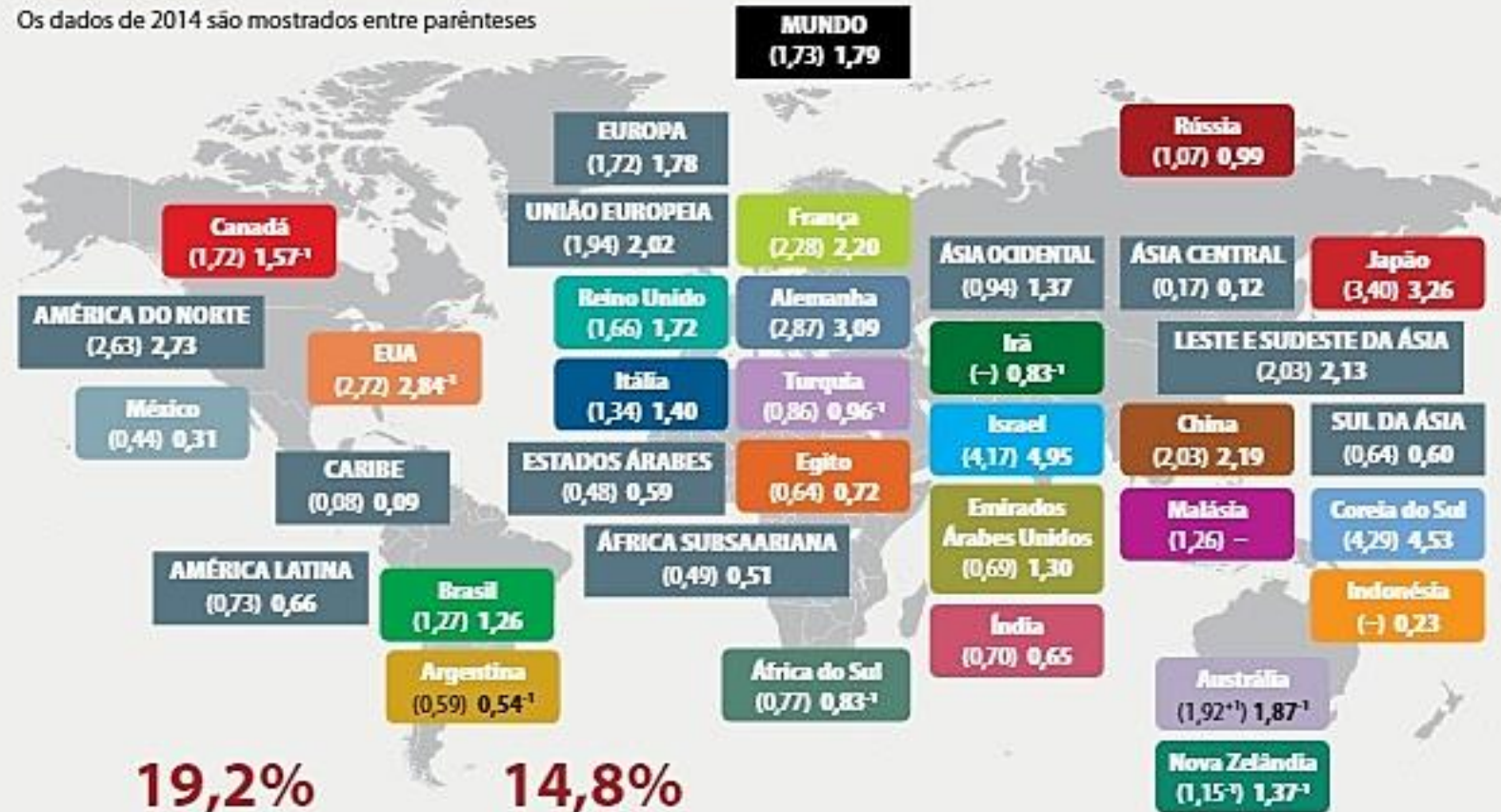

**19,2%**

Aumento dos gastos globais com pesquisa entre 2014 e 2018\*

**14,8%**

Aumento do PIB global entre 2014 e 2018\*

\* em trilhões de PPC\$ constantes de 2017

Fonte: Estimativas globais e regionais baseadas em dados nacionais do Instituto de Estatísticas da UNESCO, agosto de 2020, sem extrapolação.



# Importância da CT&I



Relatório mais recente do Ministério da Ciência, Tecnologia e Inovação (MCTI), publicado no início deste ano, **em 2019 o Brasil investiu cerca de 89,5 bilhões de reais no setor de ciência e tecnologia.** Valor que correspondeu a apenas 1,21% do PIB.





- **Introdução (Bem Comum, Poder Nacional e Expressões de Poder);**
- **Importância da Ciência, Tecnologia & Inovação (CT&I);**
- **Sistema Nacional de Ciência, Tecnologia & Inovação (SNCTI);**
- **Estratégia Nacional em Defesa;**
- **Sistema de Ciência, Tecnologia & Inovação da Marinha do Brasil (SCTIMB);**
- **IPqM – Uma História de Conquistas, Laboratórios e Projetos;**
- **Oportunidades para a Tríplice Hélice; e**
- **Considerações Finais.**



# Sistema Nacional de CTI - SNCTI



**POLÍTICOS**



(Fonte: Estratégia Nacional de CT&I (2016 -2022))

**AGÊNCIAS DE FOMENTO**



**OPERADORES DE CT&I**

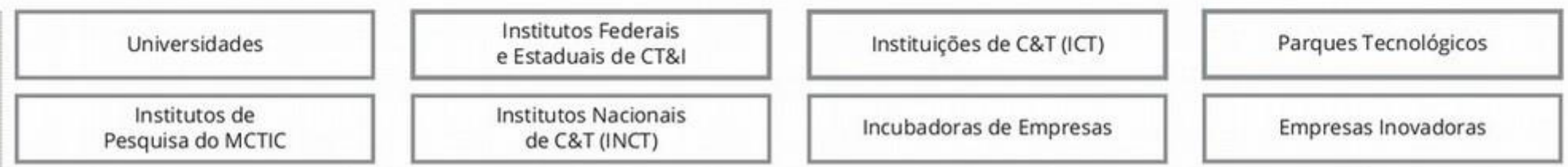

# Sistema Nacional de CTI - SNCTI



**105 anos**





# Sistema Nacional de CTI - SNCTI



Patrono da CT&I da MB - Almirante Álvaro Alberto e sua contribuição para o SNCTI



Vice-Almirante Álvaro Alberto da Mota e Silva  
\* 22 de abril de 1889, Rio de Janeiro, RJ  
+ 31 de janeiro de 1976, Rio de Janeiro, RJ



# Sistema Nacional de CTI - SNCTI



Patrono da CT&I da MB - Almirante Álvaro Alberto e sua contribuição para o SNCTI

## TRAJETÓRIA DO ALMIRANTE ÁLVARO ALBERTO

POLÍTICA  
NUCLEAR  
DO BRASIL

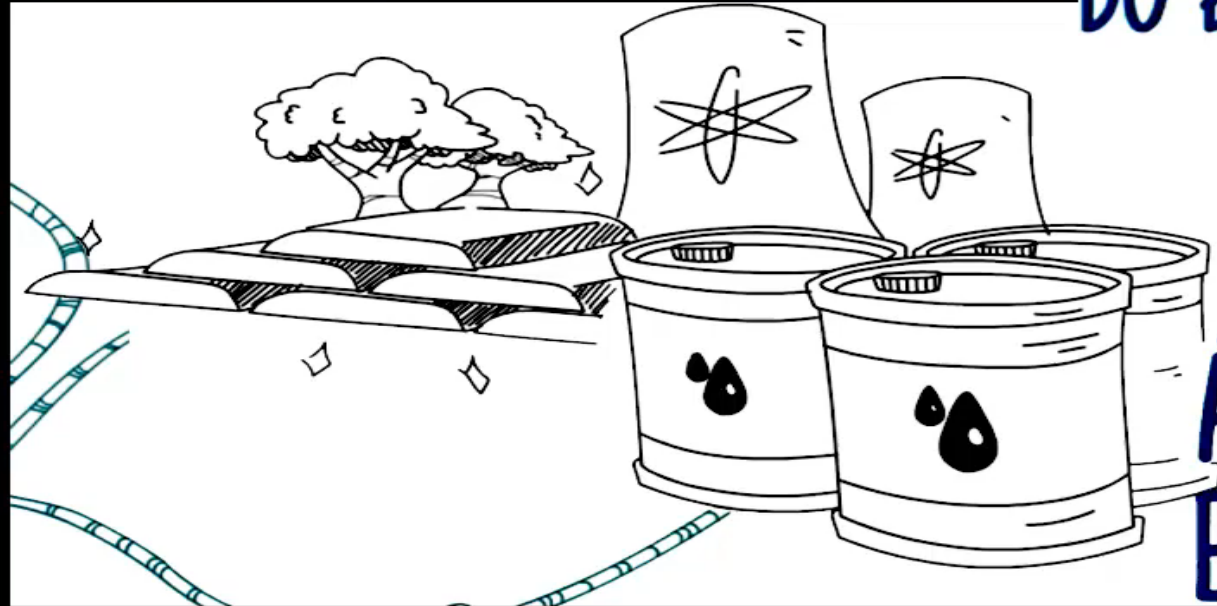

ÁREAS  
ESTRATÉGICAS





- **Introdução (Bem Comum, Poder Nacional e Expressões de Poder);**
- **Importância da Ciência, Tecnologia & Inovação (CT&I);**
- **Sistema Nacional de Ciência, Tecnologia & Inovação (SNCTI);**
- **Estratégia Nacional em Defesa;**
- **Sistema de Ciência, Tecnologia & Inovação da Marinha do Brasil (SCTIMB);**
- **IPqM – Uma História de Conquistas, Laboratórios e Projetos;**
- **Oportunidades para a Tríplice Hélice; e**
- **Considerações Finais.**





# Estratégia Nacional em Defesa

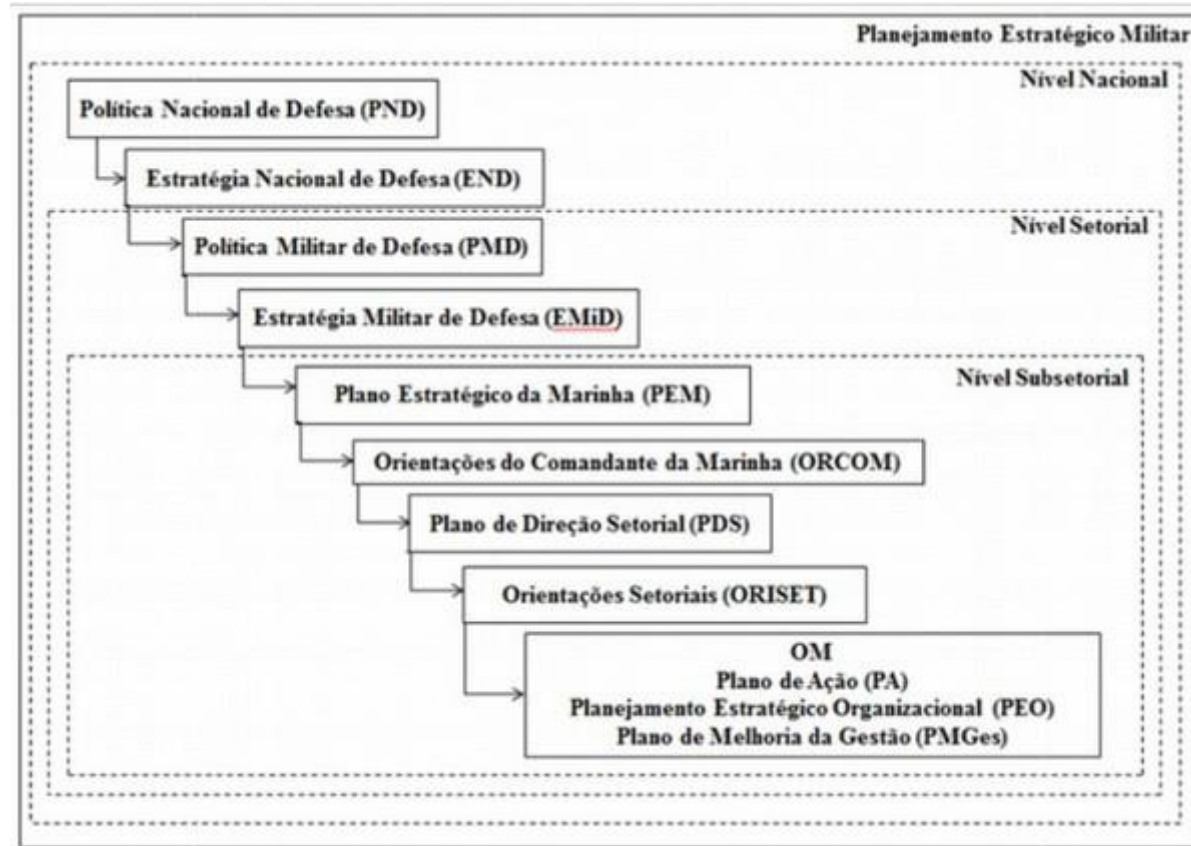
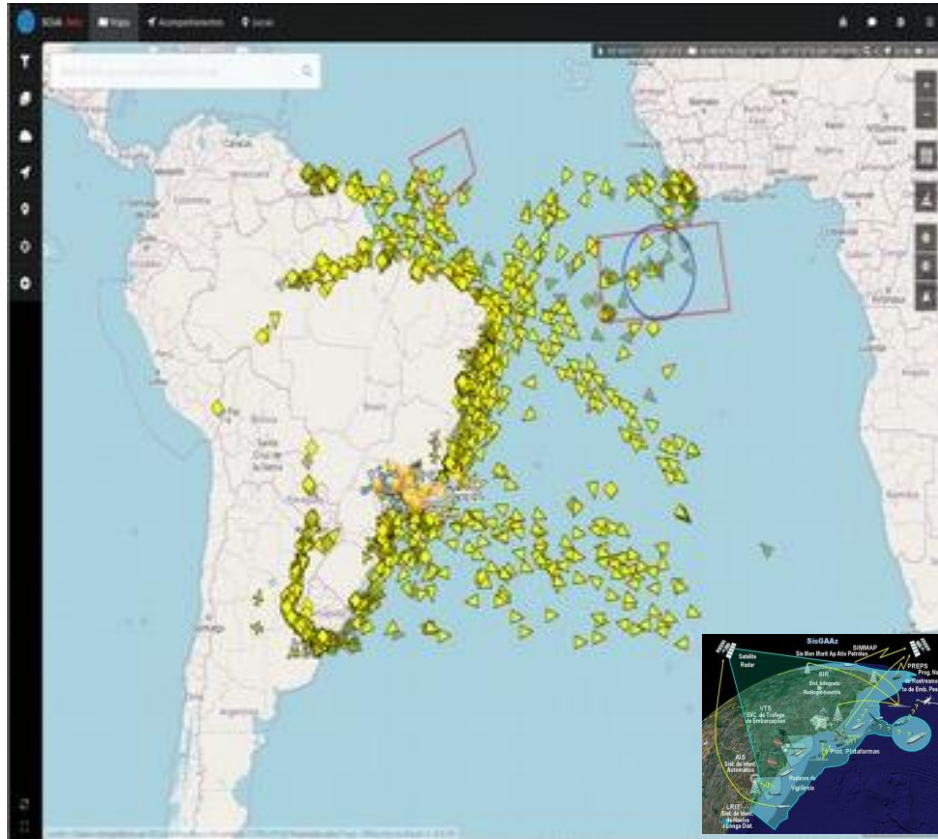

## Princípio:

Independência Nacional pela Capacidade Tecnológica Autônoma.

## Setores estratégicos:

- Nuclear (MARINHA)
- Espacial (AERONÁUTICA)
- Cibernético (EXÉRCITO)

## Força Naval organizada sob o trinômio:

- 1) monitoramento/control;e
- 2) mobilidade; e
- 3) presença.





# Estratégia Nacional em Defesa

## Documentos Condicionantes

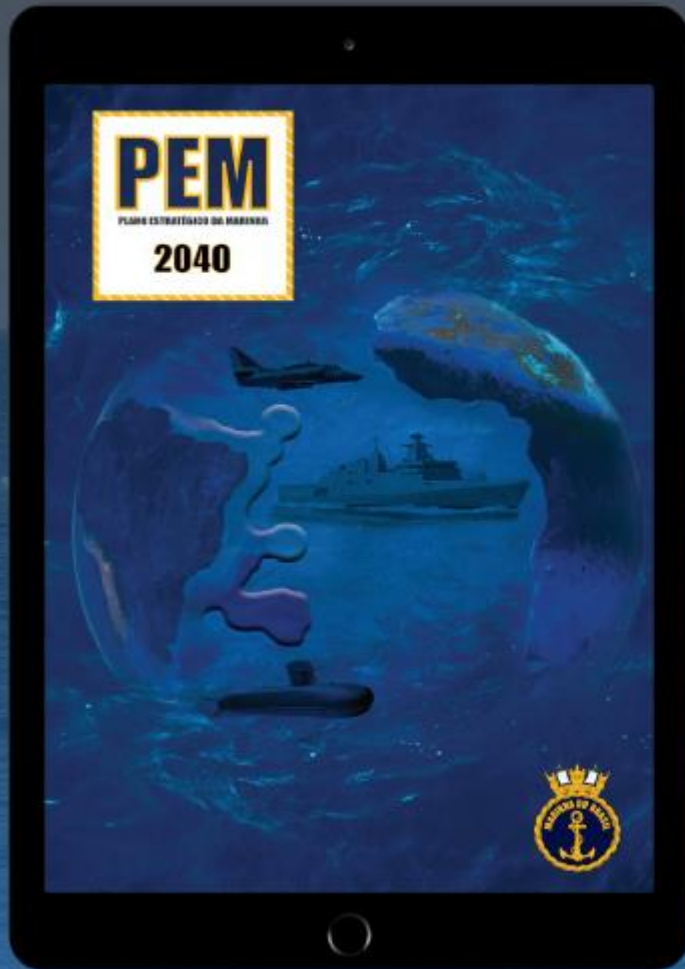

**OBNAV 1 – CONTRIBUIR PARA DEFESA DA PÁTRIA**

**OBNAV 2 – PROVER A SEGURANÇA MARÍTIMA**

**OBNAV 3 – CONTRIBUIR PARA A GARANTIA DOS PODERES CONSTITUCIONAIS E DA GLO**

**OBNAV 4 – COOPERAR COM O DESENVOLVIMENTO NACIONAL**

**OBNAV 6 – MODERNIZAR A FORÇA NAVAL**





- **Introdução (Bem Comum, Poder Nacional e Expressões de Poder);**
- **Importância da Ciência, Tecnologia & Inovação (CT&I);**
- **Sistema Nacional de Ciência, Tecnologia & Inovação (SNCTI);**
- **Estratégia Nacional em Defesa;**
- **Sistema de Ciência, Tecnologia & Inovação da Marinha do Brasil (SCTIMB);**
- **IPqM – Uma História de Conquistas, Laboratórios e Projetos;**
- **Oportunidades para a Tríplice Hélice; e**
- **Considerações Finais.**





# Sistema de Ciência, Tecnologia e Inovação da Marinha do Brasil - SCTIMB



**Comandante da Marinha**



**Estado-Maior da Armada**



**Diretoria-Geral de Desenvolvimento Nuclear e Tecnológico da Marinha**

Nível Estratégico: Priorização da Carteira de Projetos da MB

Centro Tecnológico da Marinha em São Paulo



Centro Tecnológico da Marinha no Rio de Janeiro

Nível Tático: Gestão dos Recursos Humanos e Financeiros



**Instituições de Ciência e Tecnologia da MB (ICT-MB)**



Nível Operacional: Execução dos Projetos de Desenvolvimento de Sistemas para a MB

- Programa Nuclear da Marinha (PNM)
- Programa de Desenvolvimento de Submarinos (PROSUB)

- Projetos de Ciência, Tecnologia e Inovação





**22 de Abril:  
Dia da  
Ciência,  
Tecnologia  
e Inovação  
na Marinha**







# SCTIMB - Maturidade Tecnológica

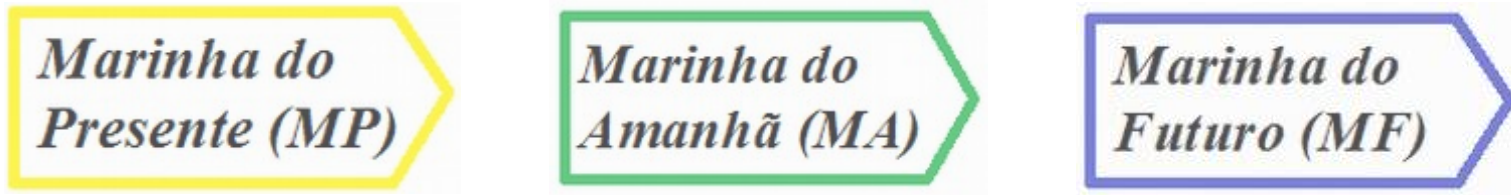

TRL	DESCRIÇÃO	ODS
9	SISTEMA REAL EMPREGADO E BEM SUCEDIDO EM MISSÕES OPERACIONAIS	ComOpNav CGCFN DGN DGMM
8	SISTEMA REAL COMPLETO E QUALIFICADO EM TESTES E DEMONSTRAÇÕES	
7	PROTÓTIPO DO SISTEMA/SUBSISTEMA DEMONSTRADO EM AMBIENTE OPERACIONAL	
6	PROTÓTIPO OU MODELO DO SISTEMA/SUBSISTEMA DEMONSTRADO EM AMBIENTE REPRESENTATIVO	
5	COMPONENTE OU MODELO DE BANCADA VALIDADO EM AMBIENTE REPRESENTATIVO	
4	COMPONENTE OU MODELO DE BANCADA VALIDADO EM LABORATÓRIO	DGDNTM
3	CARACTERÍSTICA OU FUNÇÃO CRÍTICA DO CONCEITO COMPROVADA ANALÍTICA E EXPERIMENTALMENTE	
2	CONCEITO TECNOLÓGICO E/OU APLICAÇÃO FORMULADOS	
1	PRINCÍPIOS BÁSICOS OBSERVADOS E/OU DESCRITOS	



# Sistema de Ciência, Tecnologia e Inovação da Marinha do Brasil - SCTIMB





- **Introdução (Bem Comum, Poder Nacional e Expressões de Poder);**
- **Importância da Ciência, Tecnologia & Inovação (CT&I);**
- **Sistema Nacional de Ciência, Tecnologia & Inovação (SNCTI);**
- **Estratégia Nacional em Defesa;**
- **Sistema de Ciência, Tecnologia & Inovação da Marinha do Brasil (SCTIMB);**
- **IPqM – Uma História de Conquistas, Laboratórios e Projetos;**
- **Oportunidades para a Tríplice Hélice; e**
- **Considerações Finais.**



# IPqM – Um História de Conquistas



**63 anos**





## Segunda Guerra Mundial (1939-1945)



Radar Würzburg



Bomba Atômica

- Novos sensores e armas com **tecnologias eletrônica e nuclear, como o Radar e a bomba atômica**, quebraram não só paradigmas tecnológicos, como causaram mudanças disruptivas na política geoestratégica mundial.



# IPqM – Uma História de Conquistas



- **Em outubro de 1953**, a idéia de criação de um laboratório de pesquisas científicas e tecnológicas para a MB foi formalmente levada à consideração da Alta Administração Naval, pelo ofício do Diretor-Geral de Eletrônica da Marinha, **Almirante Paulo Nogueira Penido**, ao Ministro da Marinha, Almirante Renato de Almeida Guillobel.



Lançamento da Pedra Fundamental do IPqM  
(1955)



# IPqM – Uma História de Conquistas



- o IPqM foi criado oficialmente pelo Decreto do Poder Executivo no 46.426, de **14 de julho de 1959**, tendo, inicialmente, o foco das atividades de pesquisa nas **áreas de armamento, biologia marinha, bioquímica, oceanografia física, eletrônica, química e acústica submarina.**



# IPqM – Uma História de Conquistas



## O IPqM hoje – Visão e Estratégia:

**MISSÃO DO IPqM:** Realizar atividades de pesquisa científica, desenvolvimento tecnológico e prestação de serviços tecnológicos associados a sistemas, equipamentos, componentes, materiais e técnicas, nas áreas de:

- Sistemas de Armas & Sensores;
- Guerra Eletrônica;
- Guerra Acústica;
- Sistemas Digitais; e
- Tecnologia de Materiais.

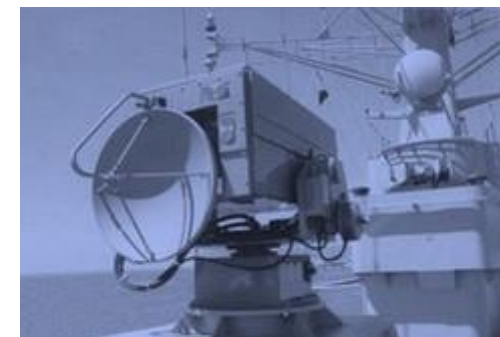

A fim de contribuir para a independência tecnológica do Brasil, o desenvolvimento da BID e o fortalecimento do Poder Naval.

**VISÃO DE FUTURO DO IPqM:** “Ser reconhecido como uma ICT de referência, no âmbito do governo federal, nos campos da pesquisa científica e do desenvolvimento tecnológico, nas suas áreas de atuação”.





# Instituto de Pesquisas da Marinha: Uma história de conquistas



- **Projeto Cabo Frio (IEAPM)**
- Foguete BOROC
- Loop 150
- Espoleta Acústica do Foguete BOROC
- Canhão de Tiro Rápido
- CME- 1
- Mina de Contato (MFC)
- Navegador por Satélite (NAVSAT)
- Gerador de Alvo Radar (GAR)
- Unidade de Morse Automática (UMA)
- Unidade de Varredura Automática (UVA)
- Sistema de Simulação Tática I (SST I)



- Concentrado Proteico de Peixe
- Tinta Tóxica contra esquistossomose



- SICONTA Mk1
- Foguete chaff
- MAGE Defensor Mk1
- CME - 2
- CME - 1A
- SLDM - Desenvolvimento de Protótipo
- MFI



- Elastômero para encapsulamento de transdutores hidroacústicos

**Projetos Estratégicos da MB**





Ato de Fundação  
Decreto 46.426  
1959

1970

1980

1990

2000

2010

2020

- Substituição das Memórias dos Submarinos
- Substituição das Fitas Magnéticas dos Sistemas Ferrante
- Mistura fumígena para canister de granada de 105mm light gun

- Mina de Casco
- Foguete ASROC
- Extrator Radar I
- Link YB
- Tinta Absorvedora de Microondas – Banda X
- Propelente Compósito para Emprego em Foguete Chaff
- Cerâmicas Piezoelétricas

- SICONTA Mk1
- SLDM nas Fragatas Niterói e Corvetas Barroso
- Mina de Fundo
- SCM da Cv Barroso
- SCAV Navios Balizadores Classe Comandante Vanela
- Cerâmicas para Blindagem Balística
- Defesa NBQR
- SDAC

- SCM do NPa Macaé e Macau
- SCAV do NE Brasil
- Software de Análise ELINT
- SAAMP
- VIPP
- ADCP
- SCC
- Sistema Tilt Test
- Estudo em Biodiesel naval
- Propelente para munição de alcance estendido
- SMB
- SCAV
- SIMNAV
- SisC2Geo
- SSTT 3
- MODPRES
- SimMaq
- CISNE
- SimPer

- Cerâmicas piezoelétricas esféricas
- Processos químicos em membranas
- Dessalinização por membranas
- SISCARE
- Guia de laboratórios - - Materiais magnéticos em geopolímeros para combate em derramamento de óleos

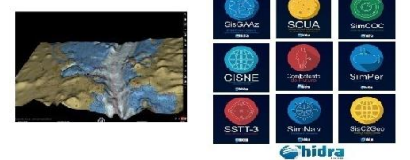
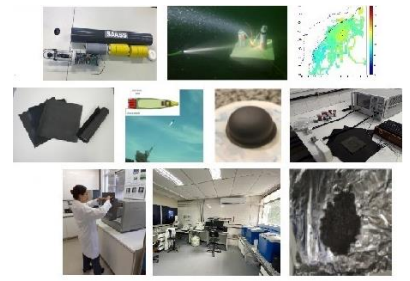

Pedra Fundamental  
1955

# IPqM: Laboratórios



Laboratório de Sistemas Inerciais (LabSIn)



Laboratório de Microondas para Caracterização de Componentes e Subsistemas



Laboratório de Processamento e Caracterização de Cerâmicas Avançadas



Laboratório de Metrologia Dimensional



Tanque de Testes Hidroacústicos



Laboratório de Análise Térmica e Calorimetria



Laboratório de Prototipagem 3D\*



Laboratório de Encapsulamento de Transdutores Hidroacústicos



Lab. de Process. de Polímeros Especiais (MICROUSINA)



Câmara Anecóica para Ensaio de Antenas Radar

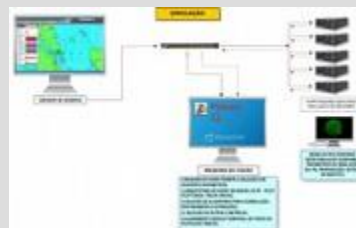

Laboratório de Simulação de Sistemas de Sensores (LS3)



Central Analítica





- **Medidas de Apoio à Guerra Eletrônica (MAGE);**
- **Sonar Ativo da MB (SONAT-MB);**
- **Sistema Tático de Enlace de Dados em Rádio Frequência Naval (STERNA);**
- **Projeto de Monitoramento da Paisagem Acústica da Bacia de Santos (PMPAS);**
- **Centro de Integração de Sensores e Navegação Eletrônica (CISNE);**
- **Sistema de Comando e Controle Georreferenciado (SisC2Geo);**
- **Sistema de Consciência Situacional Unificada por Aquisição de Informações Marítimas (SCUA);**
- **Sistema de Controle e Monitoração (SCM); e**
- **Sistemas Marítimos Não-Tripulados (SMNT) – Veículo Submarino Autônomo (VSA).**





# Teorias e Técnicas de Eletrônica aplicadas



## SENSORES

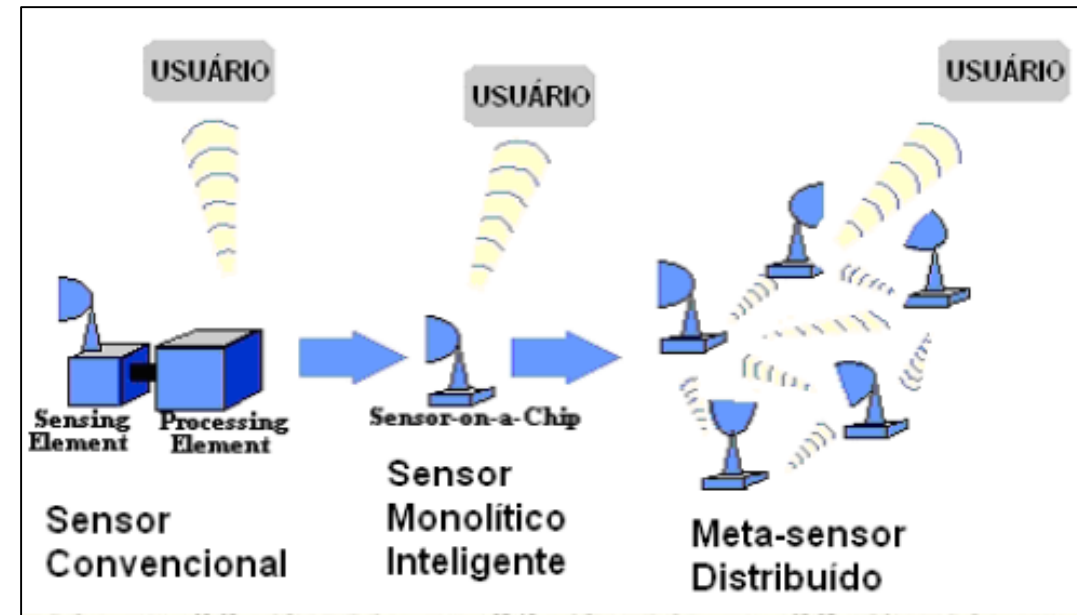



# DILEMA

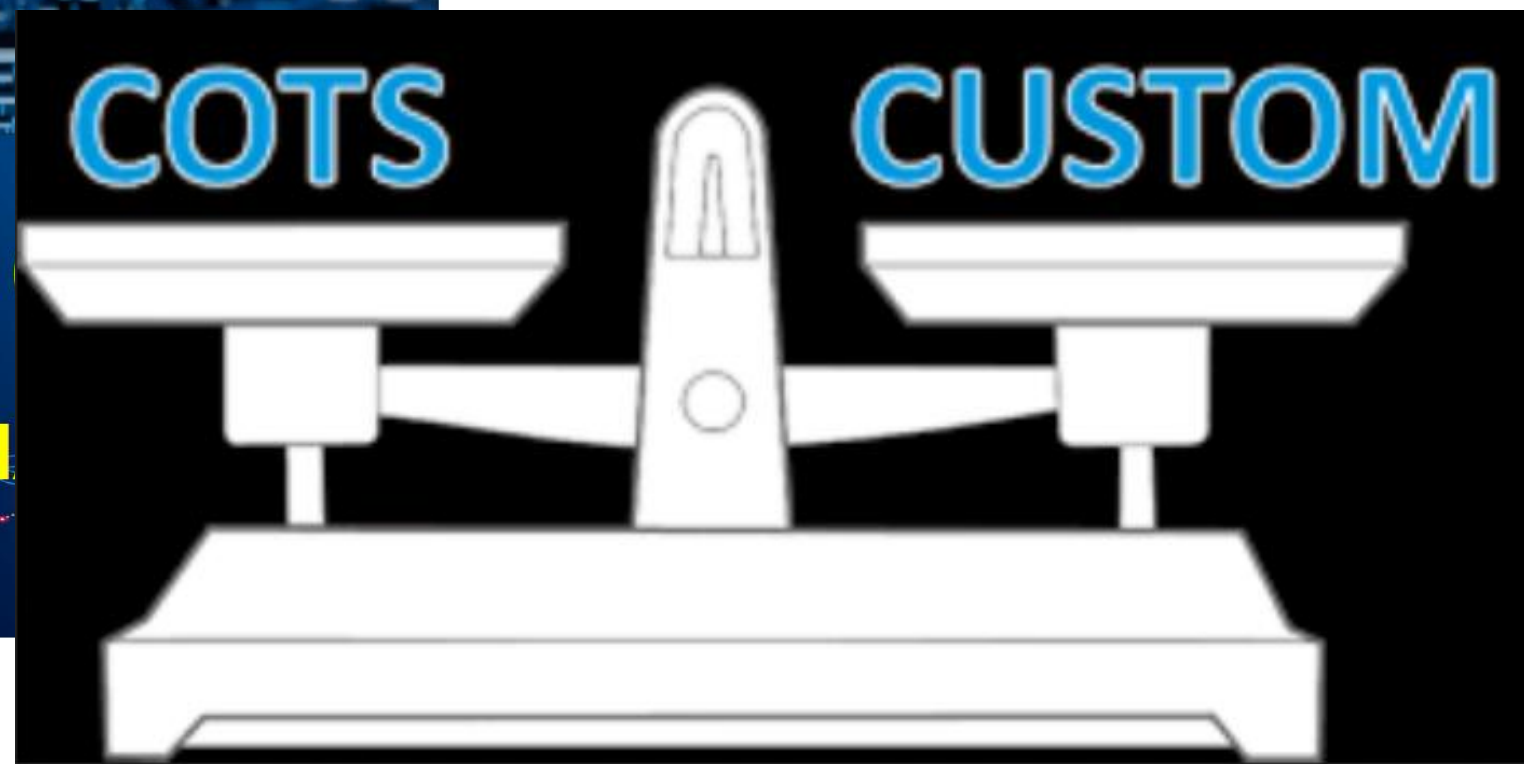

SENSORES

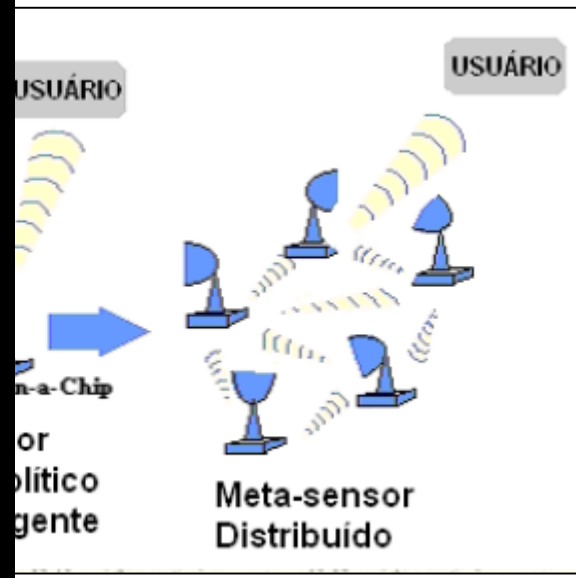

CIÊNCIA





## Medidas de Apoio à Guerra Eletrônica (MAGE)

- Escopo: Desenvolver família de equipamentos de emprego militar de monitoramento do espectro eletromagnético que detecta emissões radares a grandes distâncias. No escopo da Família MAGE Defensor estão os projetos:



MAGE Defensor Mk1 (em operação)



MAGE Veicular (protótipo)



CPU da URP do MAGE



Gabinete da URP do MAGE



Cabos de interligação URP-UA



Digitalizador do Receptor Digital



MAGE Defensor Mk3  
(Fragatas Classe Tamandaré)

## FAMÍLIA MAGE DEFENSOR





## Medidas de Apoio à Guerra Eletrônica (MAGE)

- Principais características: Banda Ultralarga; Faixa dinâmica larga; Inteligência Eletrônica (ELINT); e identificação do ângulo de chegada.
- Impacto ou consequência do desenvolvimento do projeto para a MB e demais FFAA:
  - > Adoção do equipamento como padrão na MB;
  - > Transferência da Tecnologia para o setor produtivo (BID)
- Possíveis Desdobramentos:
  - > MAGE Defensor Mk4 (submarinos)
  - > MAGE Defensor Mk5 (Aeronaves)

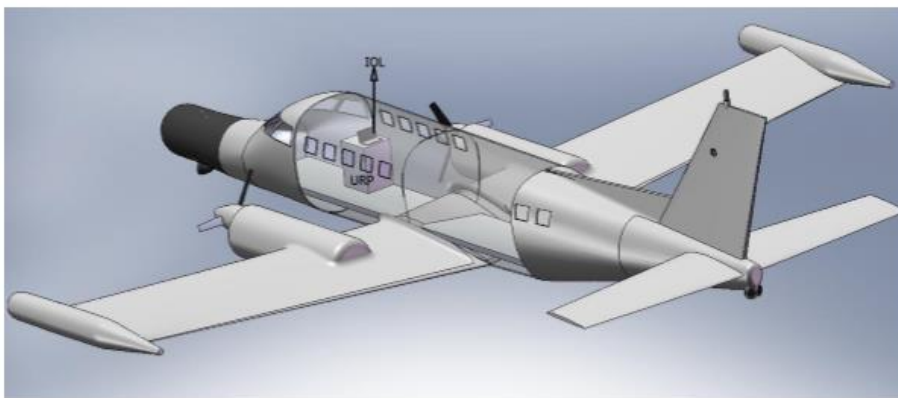



## Medidas de Apoio à Guerra Eletrônica (MAGE)

ARQUITETURA DO SISTEMA MAGE

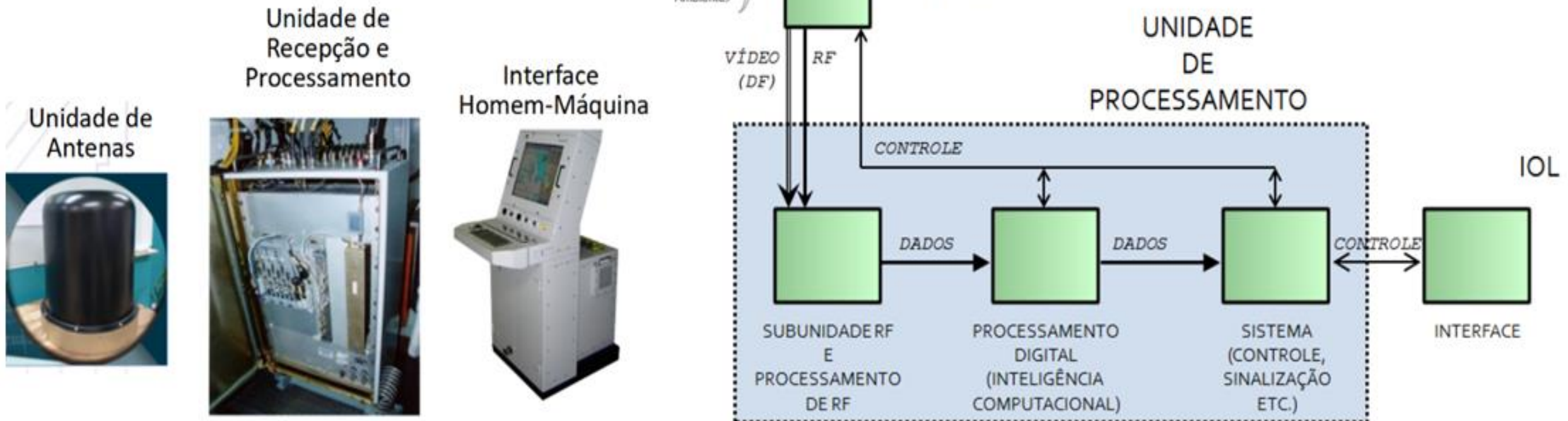







## Sonar Ativo da MB (SONAT-MB)

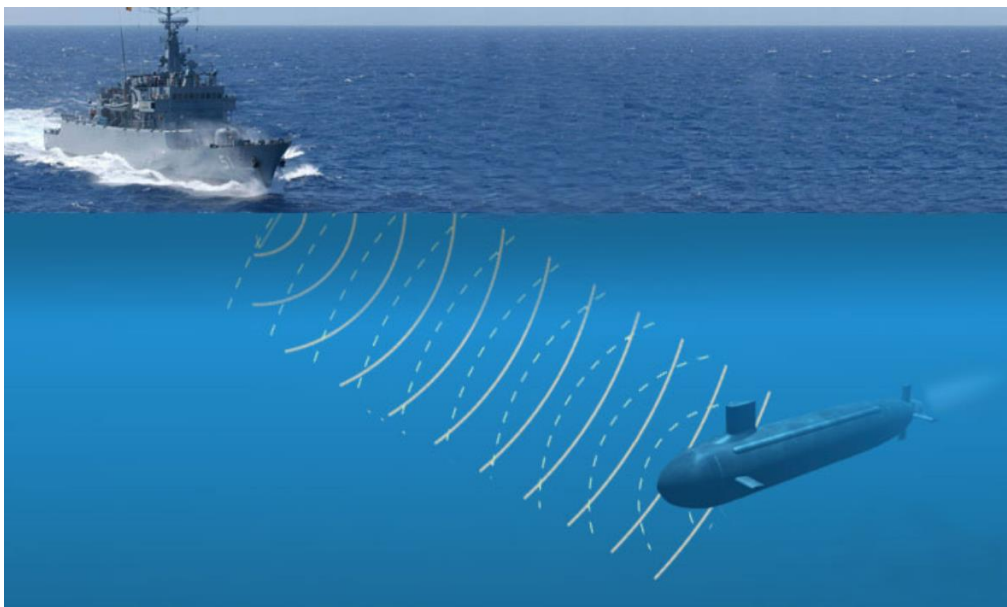



## Sonar Ativo da MB (SONAT-MB)





## Sistema Tático de Enlace de Dados em Rádio Frequência Naval (STERNA)

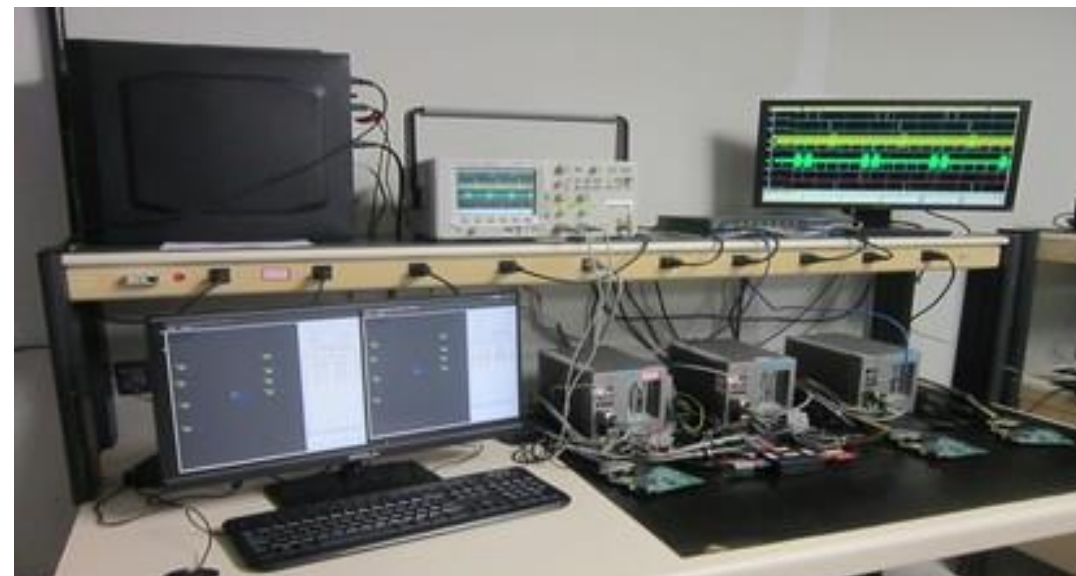



## STERNA: Arquitetura

Sistema de Gerenciamento de Combate - CMS

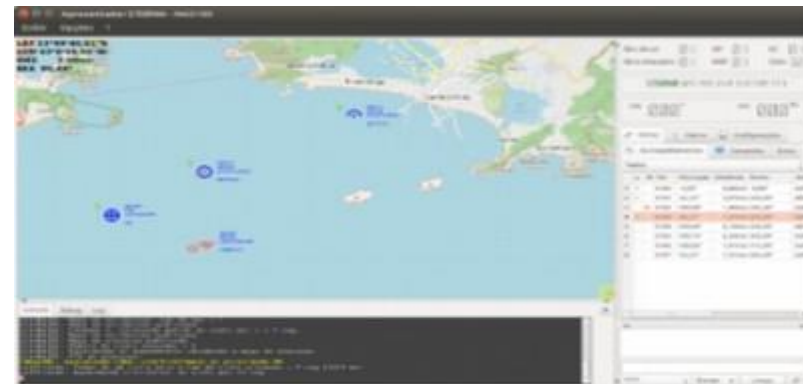
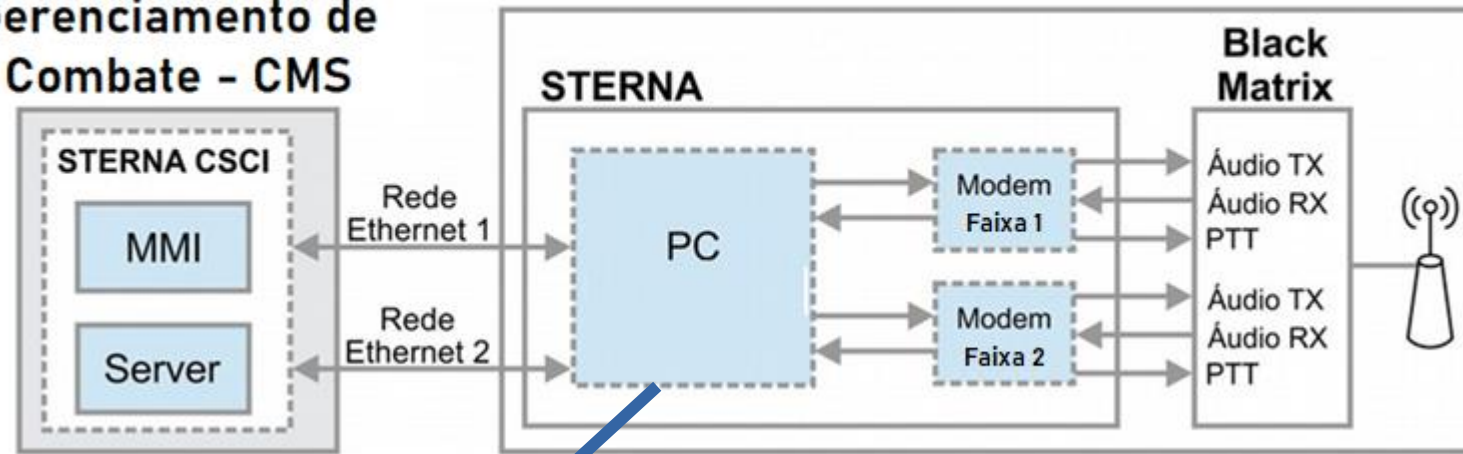



## Projeto de Monitoramento da Paisagem Acústica da Bacia de Santos (PMPAS)

- Modelos de Propagação Acústica
- Banco de Dados das informações coletadas
- Nacionalização de Transdutores
- Sistema Autônomo de Aquisição de Sinais Submarinos (SAASS)

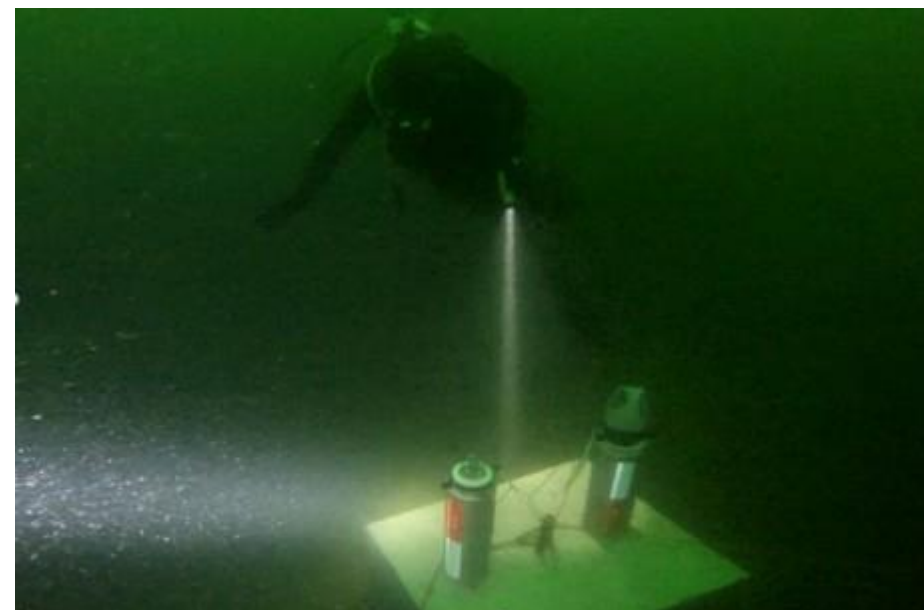



## Centro de Integração de Sensores e Navegação Eletrônica (CISNE)





## Sistema de Comando e Controle Georreferenciado (SisC2Geo)







## Sistema de Consciência Situacional Unificada por Aquisição de Informações Marítimas (SCUA)



Com 7,4 mil quilômetros de costa, o Brasil tem, sob sua jurisdição, **3,5 milhões de quilômetros quadrados (km<sup>2</sup>) de espaço marítimo.**

Navegação, pesca, turismo, geração de energia renovável, e, principalmente, extração de petróleo e gás fazem da faixa oceânica fundamental para a economia e a soberania do país. A ponto de o Brasil pleitear junto à Organização das Nações Unidas (ONU) a **ampliação do que é chamado de Zona Econômica Exclusiva (ZEE) em mais 2 milhões de km<sup>2</sup>.**





## Sistema de Consciência Situacional Unificada por Aquisição de Informações Marítimas (SCUA)

Desenvolver um sistema que...

- Integre os radares do sistema de VTS do Porto do Rio de Janeiro e os dados provenientes dos sistemas VTS já existentes em Vitória e Açu;
- Integre todas as estações fixas de vigilância a serem adquiridas pela MB;
- Expanda o acesso para os demais Distritos Navais;
- Incorpore todos os sensores de navios da MB com CISNE/SisC2Geo;
- Incorpore os contatos detectados pelo sistema de vigilância acústica submarina desenvolvido pelo IPqM;
- Incremente a monitoração e a atuação por dispositivos móveis;
- Integre com os sistemas SISTRAM, CITRA, CENSIPAM e de planejamento de SAR;
- Permita a interoperabilidade com outros sistemas governamentais;
- Incorpore todas as funcionalidades do SAGBD;
- Execute previsões sistêmicas de evolução do cenário operativo e detecte ameaças e comportamentos anômalos.

**SCUA + SisGAAz (Sistema de Gerenciamento da Amazônia Azul)**



# IPqM: Projetos com foco em Teorias e Técnicas de Eletrônica aplicadas

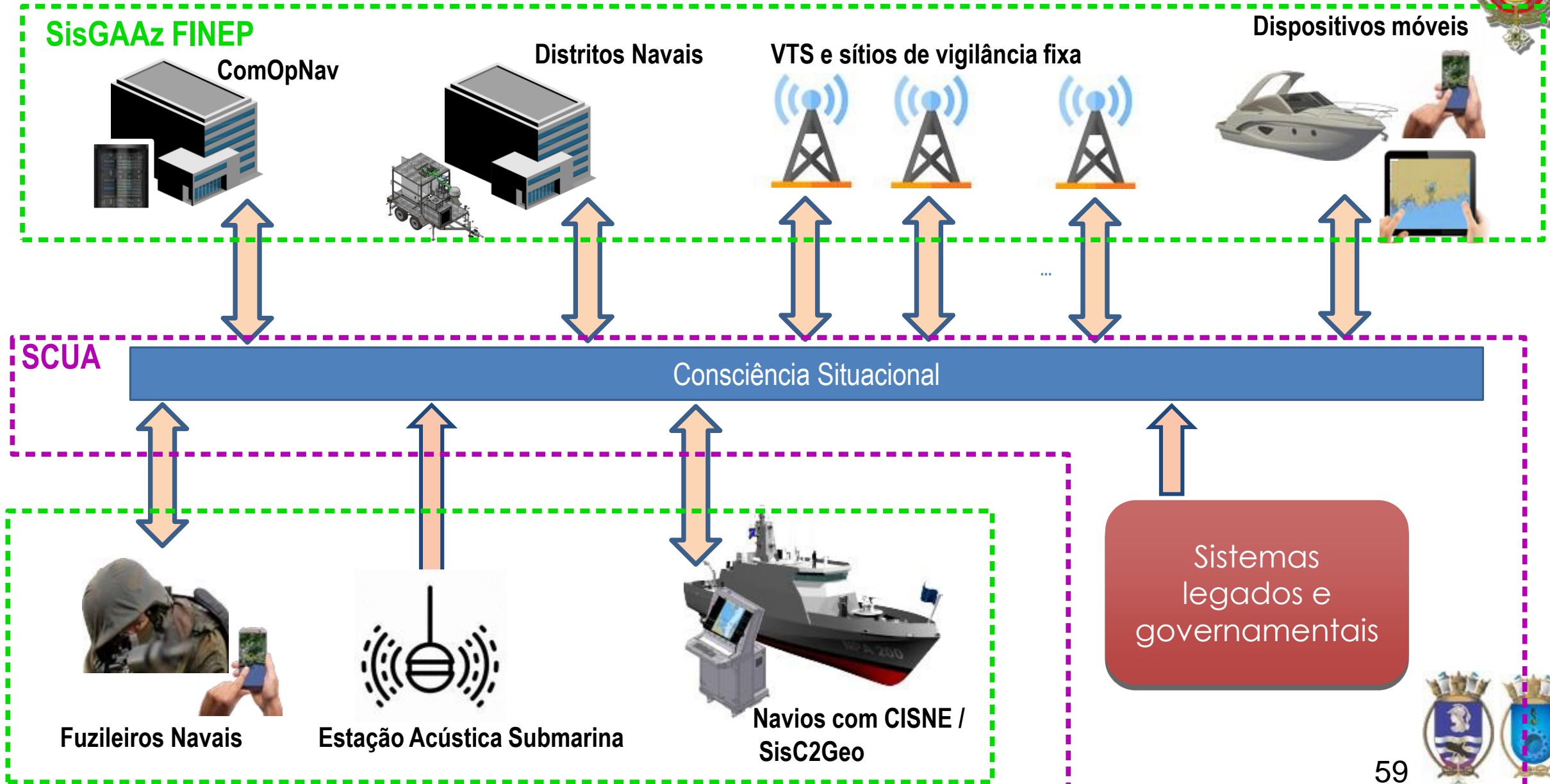



## Sistema de Controle e Monitoramento (SCM)



- ❖ Monitorar e Controlar a instalação Propulsora do Navio.
- ❖ Monitorar e atuar em equipamentos auxiliares.
- ❖ Monitorar a ocorrência de avarias diversas.





## Sistema de Controle e Monitoramento (SCM)

### ❖ Subsistemas

- ✓ Subsistema de Controle e Monitoração da Propulsão e Auxiliares (SCMPA).
- ✓ Subsistema de Controle de Avarias (SCAV).
- ✓ Subsistema Manual Remoto (SMR).





## Sistema de Controle e Monitoramento (SCM)

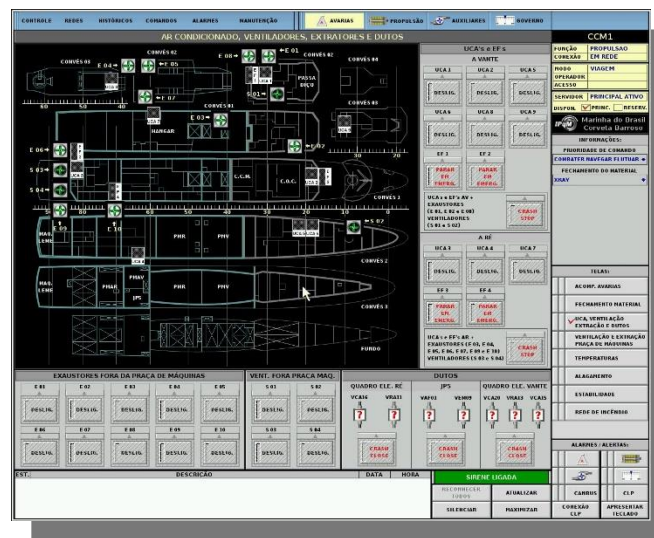
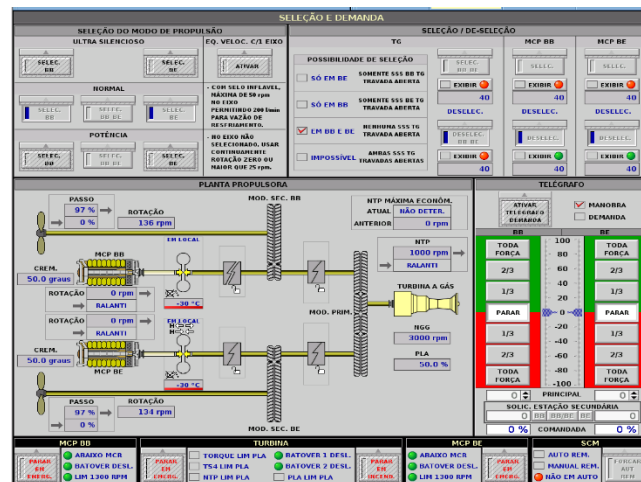



## Sistema de Controle e Monitoramento (SCM) - Unidades



Teclado robustecido

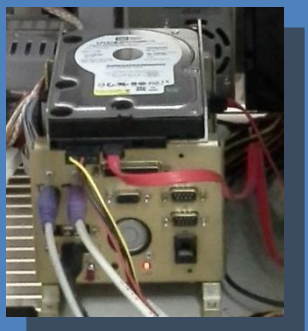

Computador Industrial padrão



Consoles

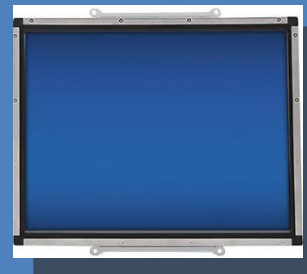

Monitor LCD



Fonte de Alimentação



Placas de Rede



Cartões e CLPs



Remotas de Aquisição de Dados – Propulsão e Auxiliares



Switch Industrial



# Sistemas Marítimos Não-Tripulados

**Potencial de emprego: MCM, ASW, MAGE/CME, reconhecimento, patrulha, oceanografia, detecção e monitoramento de derramamento de óleo, etc**

**Implantação de Lab SMNT**

**Iniciativas MB e extra-MB**







# Sistemas Marítimos Não-Tripulados

## ROADMAP TECNOLÓGICO

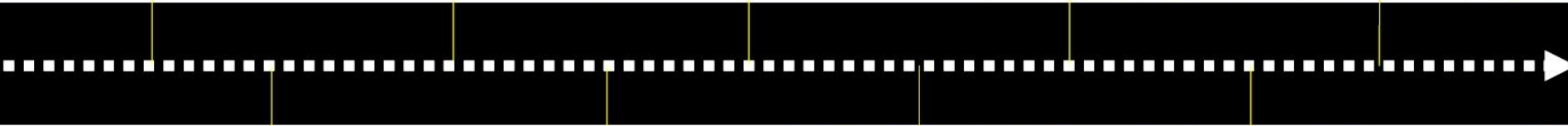



# Sistemas Marítimos Não-Tripulados

## ROADMAP TECNOLÓGICO

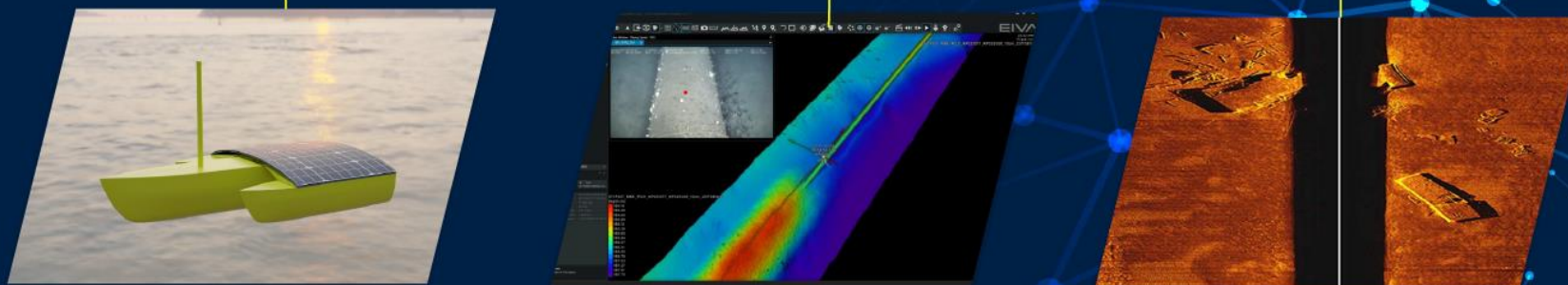



# Sistemas Marítimos Não-Tripulados

## Veículo Submarino Autônomo - VSA

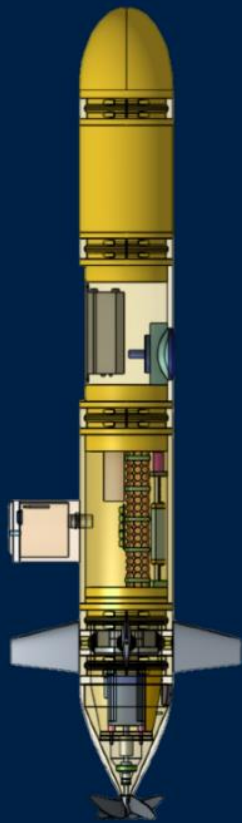

O objetivo do projeto é o desenvolvimento e integração de um protótipo de plataforma autônoma submarina multipropósito apoio a atividades de contramedidas minagem.





# Sistemas Marítimos Não-Tripulados

## Veículo Submarino Autônomo - VSA

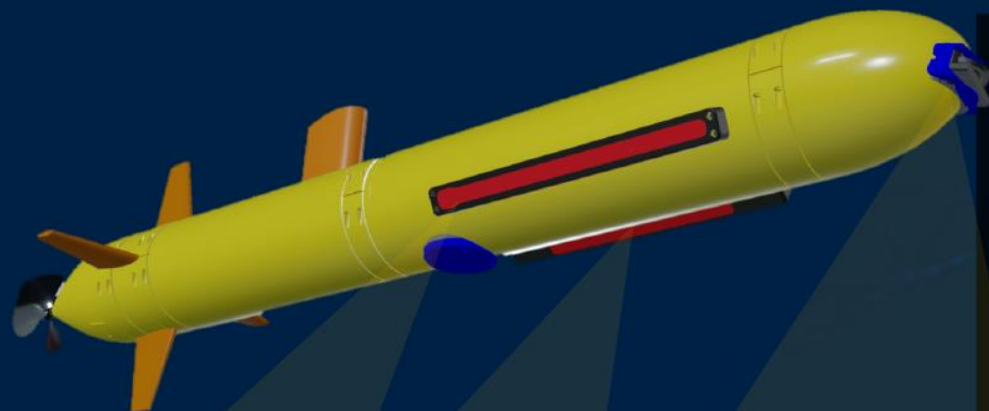

O objetivo do projeto é o desenvolvimento e integração de um protótipo de plataforma autônoma submarina multipropósito apoio a atividades de contramedidas minagem.

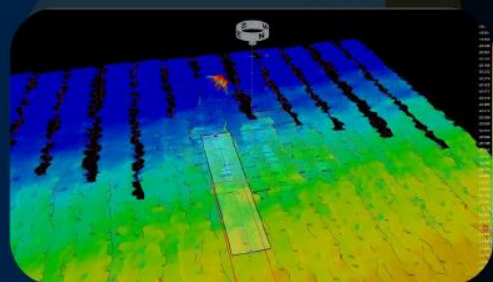
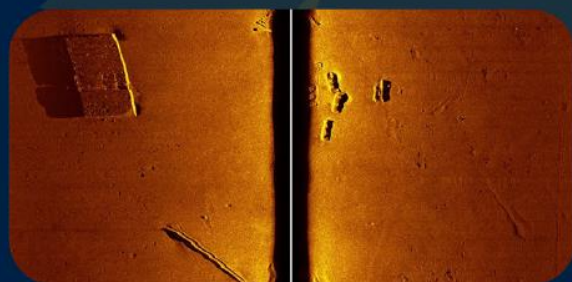



# Sistemas Marítimos Não-Tripulados - VSA

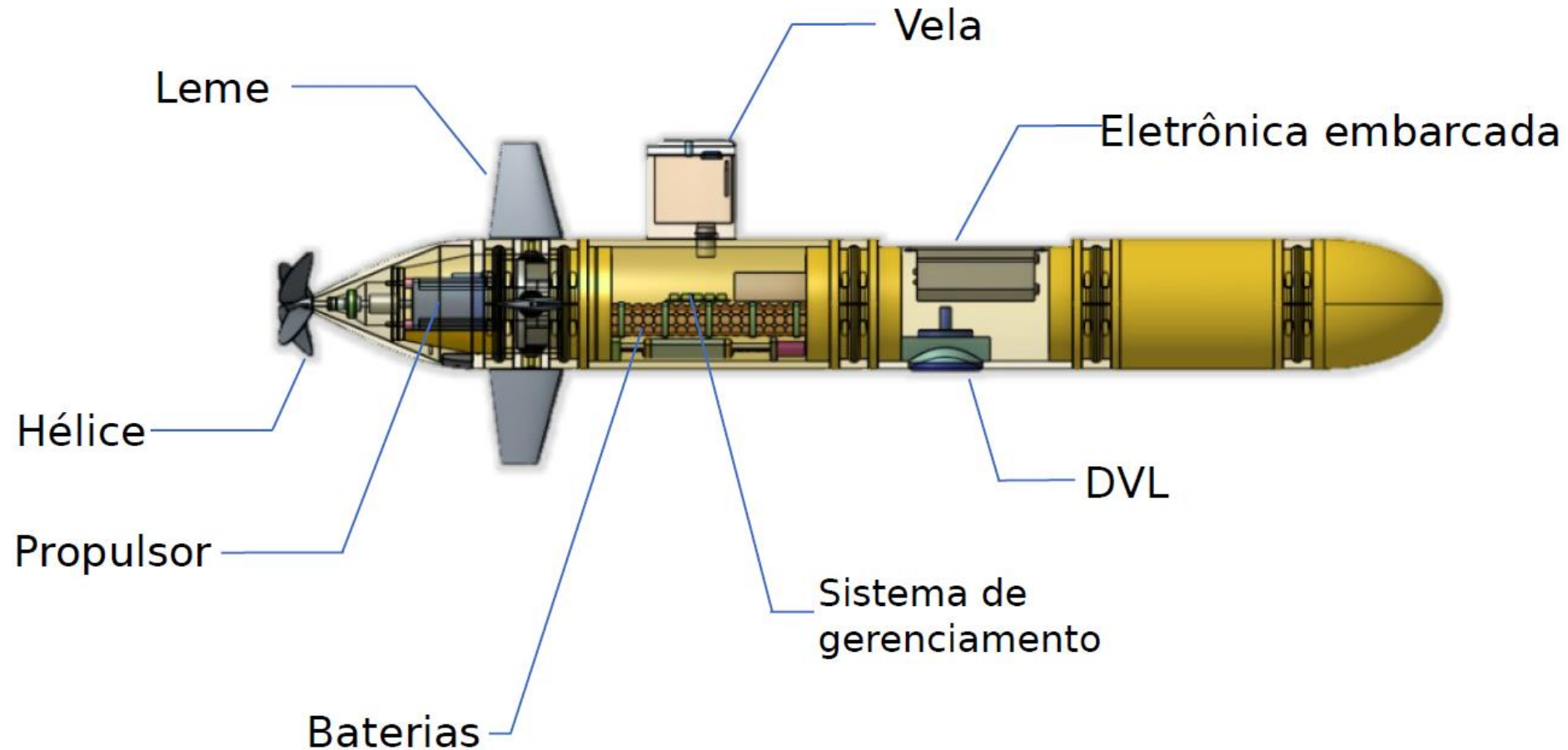



- **Introdução (Bem Comum, Poder Nacional e Expressões de Poder);**
- **Importância da Ciência, Tecnologia & Inovação (CT&I);**
- **Sistema Nacional de Ciência, Tecnologia & Inovação (SNCTI);**
- **Estratégia Nacional em Defesa;**
- **Sistema de Ciência, Tecnologia & Inovação da Marinha do Brasil (SCTIMB);**
- **IPqM – Uma História de Conquistas, Laboratórios e Projetos;**
- **Oportunidades para a Tríplice Hélice; e**
- **Considerações Finais.**



# Oportunidades para a Tríplice Hélice



# Oportunidades para a Tríplice Hélice



## SisMoM – Parceria com o INPE

- Sistema Multiusuário de Detecção, Previsão e Monitoramento de Derrame de Óleo no Mar (SisMoM) - INPE
- Oportunidades (Metas):
  - Estudo para viabilizar a futura aquisição e integração ao sistema de Veículos Não Tripulados para a MB; e
  - Integração do SisMoM ao SisGAAz.
- Recursos para o IPqM (a ser confirmado):
  - Humanos: bolsistas (DTI-B e DTI-C), sendo divididas em 2 equipes iguais para cada Meta Física associada; e
  - Materiais: Aquisição de computadores, softwares e insumos para os Lab. de Desenvolvimento de Software e de Veículos Não Tripulados.

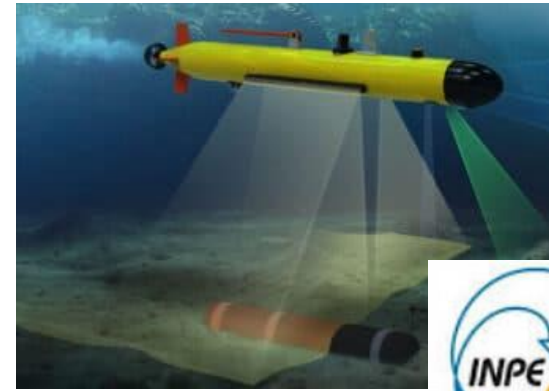



# Oportunidades para a Tríplice Hélice



Ir para o conteúdo **1** Ir para o menu **2** Ir para a busca **3** Ir para o rodapé **4**

ACESSIBILIDADE ALTO CONTRASTE MAPA DO SITE



Diretoria-Geral de

## Desenvolvimento Nuclear e Tecnológico da Marinha

MARINHA DO BRASIL

f t v You Tube

Ministério da Defesa | Marinha do Brasil | Comunicação Social

[INÍCIO](#) / [OFERTAS TECNOLÓGICAS](#)

**INSTITUCIONAL**

[Missão](#)

[Visão](#)

[Heráldica](#)

## Ofertas Tecnológicas

[\[Início\]](#) [\[ICTs da Marinha\]](#) [\[Documentos\]](#) [\[Ofertas Tecnológicas\]](#) [\[Fundações de Apoio\]](#) [\[Modelos de Negócios\]](#) [\[Contato\]](#)

<https://www.marinha.mil.br/dgdntm>



# Oportunidades para a Tríplice Hélice



Ir para o conteúdo 1 Ir para o menu 2 Ir para a busca 3 Ir para o rodapé 4

ACESSIBILIDADE ALTO CONTRASTE MAPA DO SITE

Buscar 

 Diretoria-Geral de  
**Desenvolvimento  
Nuclear e Tecnológico da  
Marinha**

MARINHA DO BRASIL

Ministério da Defesa | Marinha do Brasil | Comunicação Social

Fale com o NIT-MB:

RUA DA PONTE - S/Nº - EDIFÍCIO 23 DO AMRJ, 2º ANDAR, ILHA DAS COBRAS - CENTRO - RIO DE JANEIRO - RJ - BRASIL - 20091-000

Tel: (21) 2197-7447

[nit.mb@marinha.mil.br](mailto:nit.mb@marinha.mil.br) 

<https://www.marinha.mil.br/dgdntm>



# Oportunidades para a Tríplice Hélice



[Ir para conteúdo 1](#) [Ir para o menu 2](#) [Ir para a busca 3](#) [Ir para o rodapé 4](#)

[ACESSIBILIDADE](#) [ALTO CONTRASTE](#) [MAPA DO SITE](#)



Marinha do Brasil

## Centro Tecnológico da Marinha

NO RIO DE JANEIRO



[Contato](#)

Em destaque

Contato

### INSTITUCIONAL

[Histórico](#)

[Diretores](#)

[Heráldica](#)

[Missão e Visão](#)

[Política da Qualidade](#)

[Escopo da SGQ](#)

[Organograma](#)



<https://www.marinha.mil.br/ctmrj/>



# Oportunidades para a Tríplice Hélice



[Ir para o conteúdo](#) 1 [Ir para o menu](#) 2 [Ir para a busca](#) 3 [Ir para o rodapé](#) 4

[ACESSIBILIDADE](#) [ALTO CONTRASTE](#) [MAPA DO SITE](#)



Instituto de  
**Pesquisas da Marinha**  
MARINHA DO BRASIL



[Localização](#) | [Ministério da Defesa](#) | [Contato](#)

## INSTITUCIONAL

[Histórico](#)

[Missão](#)

[Código de Ética](#)

[Heráldica](#)

[Diretores](#)

[Carta de Serviços ao  
Usuário](#)

[Como Servir no IPqM](#)

## Seja Bem-Vindo!



[https://www.marinha.mil.br/ipqm/home\\_ipqm](https://www.marinha.mil.br/ipqm/home_ipqm)



# Oportunidades para a Tríplice Hélice



## Fundações de Apoio Credenciadas ou Autorizadas ao NIT-MB



<https://fundacaode120644.rm.cloudtotvs.com.br/FrameHTML/RM/Rhu-BancoTalentos/#/RM/Rhu-BancoTalentos/home>



<https://www.fundep.ufmg.br/vagas/vagas-projetos/>



<https://www.fdte.org.br/>



# Oportunidades para a Tríplice Hélice



**FEMAR** Banco de Talentos

Usuário:  Senha:  Entrar

[Esqueceu sua senha?](#)

Home | **Painel de Vagas** | Quero me cadastrar

### Busque Vagas

Utilize a opção "Painel de Vagas" para verificar nossas oportunidades em aberto.

[Espaço do Coordenador](#) | [Espaço do Colaborador](#) | [Portal da Transparência](#) | [Portal de Compras](#) | [Intranet](#) | [Sala de Imprensa](#)

**fundep** fundação de apoio da UFMG

[f](#) [in](#) [br](#)

**Painel de Vagas**

ASSESSOR TÉCNICO - RP 347

[FUNDEP](#) [SOLUÇÕES](#) [PARCEIROS](#) [PROJETOS](#) [CURSOS E EVENTOS](#) [CONCURSOS](#) [NOTÍCIAS](#) [VAGAS](#) [VERDE](#) [ROTA2030](#) [CONTATO](#)

[Página Inicial](#) [Vagas](#) [Vagas em Projetos](#)

## Vagas em Projetos

Trabalhe nos projetos gerenciados pela Fundep e faça parte de iniciativas tão relevantes para o desenvolvimento científico e tecnológico da nossa sociedade! As oportunidades contemplam diversas áreas do conhecimento e regiões do país. Profissionais e estudantes são muito bem-vindos! Também

### SELECIONE UM PROJETO

**FDTE**  
FUNDAÇÃO PARA O DESENVOLVIMENTO TECNOLÓGICO DA ENGENHARIA

[A FDTE](#) [ENSINO](#) [SOCIAL](#) [NOTÍCIA & MERCADO](#) [TRANSPARÊNCIA](#) [CONTATO](#)

## INOVAÇÃO EM TECNOLOGIA SUSTENTÁVEL

Unindo o conhecimento e a tecnologia em prol do ser humano.

Linha.jpg

## SERVIÇOS & SOLUÇÕES

Linha.jpg



- **Introdução (Bem Comum, Poder Nacional e Expressões de Poder);**
- **Importância da Ciência, Tecnologia & Inovação (CT&I);**
- **Sistema Nacional de Ciência, Tecnologia & Inovação (SNCTI);**
- **Estratégia Nacional em Defesa;**
- **Sistema de Ciência, Tecnologia & Inovação da Marinha do Brasil (SCTIMB);**
- **IPqM – Uma História de Conquistas, Laboratórios e Projetos;**
- **Oportunidades para a Tríplice Hélice; e**
- **Considerações Finais.**



# Considerações Finais



- Obter recursos materiais e humanos para uma agenda de Ciência e Tecnologia do tamanho da Amazônia Azul/Brasil.
- Sensibilizar atores políticos para as demandas da Força;
- Gestão baseada na eficiência e agilidade;
- Estimular uma BID competitiva e moderna: Fomento P&D x Obtenção;
- Integrar os atores da tríplice hélice (Academia x Empresas x Governo);

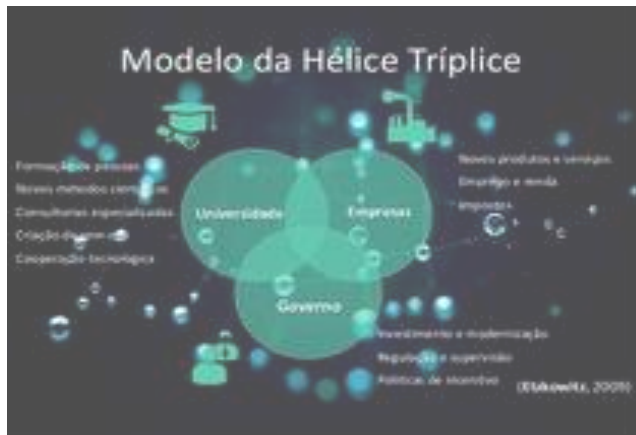



# Considerações Finais



- Reduzir o “gap” tecnológico, nas suas áreas temáticas (fronteira internacional x capacidade instalada no país);
- Dilema: Desenvolver x Comprar;
- Acordos de compensação/offset;
- Marco Legal CT&I;
- Aproximação CT&I/Material/Operativo; e
- Parceria e confiança podem reduzir custos.

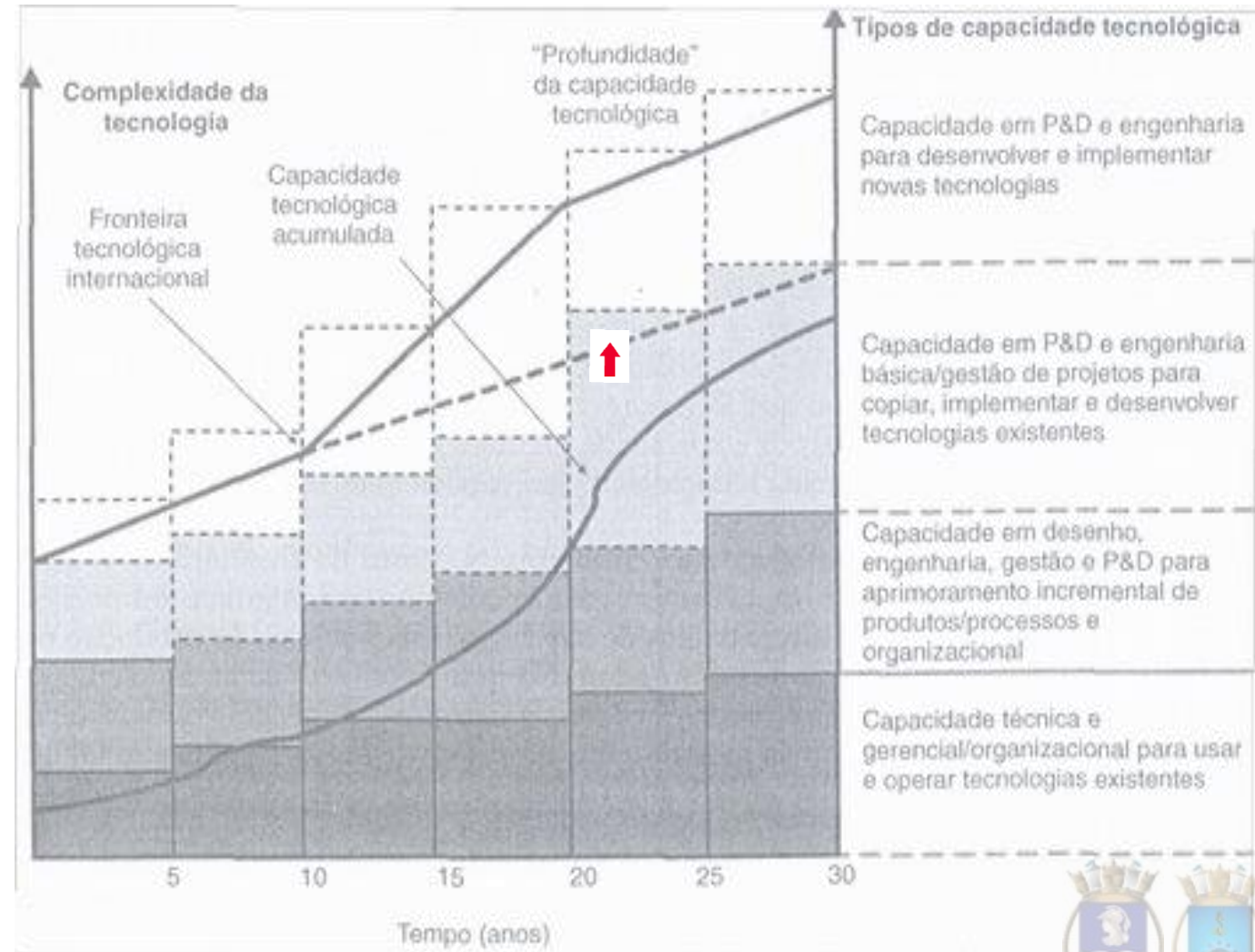



- *“... a Marinha vale pelo valor moral e intelectual de seus homens e pela força material de suas armas. Homens, entretanto, que não podem ser exceções entre os brasileiros e armas que serão enganosas se não emanarem de uma indústria produtiva e progressista, integrada numa sólida economia nacional...”*

- Paulo Nogueira Penido
- Vice-Almirante
- Diretor-Geral de Eletrônica

- Expediente 387 do Diretor-Geral de Eletrônica ao ao Exmo. Sr. Ministro da Marinha, em 18MAR1955.
- Assunto: “Criação do Instituto de Pesquisas da Marinha”





Em sua visita ao IPqM, em 20 de setembro de 1961, Robert Oppenheimer -físico norte-americano - que dirigiu o Projeto Manhattan para o desenvolvimento da bomba atômica, escreveu no então chamado “Livro de Honra do IPqM”: ***“With good wishes for the high sucess of this Institute, and with admiration for the devoted officers who had created it”***, desejando boa sorte e revelando sua admiração pelos Oficiais que criaram o Instituto.



Visita em 20 de setembro de 1961, do Físico Robert Oppenheimer ao IPqM, Chefe do Projeto Manhattan



# Palavras do Patrono de CT&I da MB ao IPqM em 1961



③ A eficiência futura da Marinha, numa época dominada pelo poder da Ciência, da Tecnologia e da Indústria, muito há de agradecer o esforço pioneiro dos que, neste Instituto, lhe dão todas as forças do Coração e da Inteligência.  
20 setembro 1961.  
Alvaro-Alberto

**"A eficiência futura da Marinha, numa época dominada pelo poder da Ciência, da Tecnologia e da Indústria, muito há de agradecer o esforço pioneiro dos que, neste Instituto, lhe dão todas as forças do coração e da inteligência" - 20 de setembro de 1961 - Alte Álvaro Alberto**



**IPqM, 63 anos de conquistas!**



**IPqM**

**Instituto de Pesquisas da Marinha**

**63 anos**



# Contatos:



**CF(EN) ALI KAMEL Issmael Junior**  
**Chefe da Célula de Controle de Projetos, Engenharia e**  
**Atividades Militares (IPqM-02)**

**E-mails:**

**[alikamel1974@gmail.com](mailto:alikamel1974@gmail.com)**

**[ali.kamel@marinha.mil.br](mailto:ali.kamel@marinha.mil.br)**

**Site Pessoal: [www.akij.com.br](http://www.akij.com.br)**



# Perguntas





*“Soberania pela ciência”*

